

Fast Calculation of the Empty Volume in Molecular Systems by the use of Voronoi-Delaunay Subsimplexes

V.P. Voloshin¹, N.N. Medvedev^{1,2} and A.Geiger³

¹ Institute of Chemical Kinetics and Combustion, SB RAS, 630090 Novosibirsk, Russia
nikmed@kinetics.nsc.ru

² Novosibirsk State University, Novosibirsk, Russia

³ Physikalische Chemie, Technische Universität Dortmund, 44221 Dortmund, Germany
alfons.geiger@udo.edu

Abstract. The calculation of the occupied and empty volume in an ensemble of overlapping spheres is not a simple task in general. There are different analytical and numerical methods, which have been developed for the treatment of specific problems, for example the calculation of local intermolecular voids or – vice versa – of the volume of overlapping atoms. A very efficient approach to solve these problems is based on the Voronoi-Delaunay subsimplexes, which are special triangular pyramids defined at the intersection of a Voronoi polyhedron and Delaunay simplex. The subsimplexes were proposed in a paper [1] (*Sastry S.et al., Phys. Rev. E, vol.56, 5524–5532, 1997*) for the calculation of the cavity volume in simple liquids. Later, the subsimplexes were applied for the treatment of the union of strongly overlapping spheres [2] (*Voloshin V.P. et al., Proc. of the 8th ISVD, 170–176, 2011*). In this article we discuss wider applications of subsimplexes for the calculation of the occupied and empty volumes of different structural units, selected in molecular systems. In particular, we apply them to Voronoi and Delaunay shells, defined around a solute, as well as their intersection. It opens a way to calculate the components of the partial molar volume of a macromolecule in solution, what is important for the interpretation of experimental volumetric data for protein solutions. The method is illustrated by the application to molecular dynamics models of a hIAPP polypeptide molecule in water at different temperatures.

Keywords. Molecular dynamics simulation, solutions, bio-molecules, partial molar volume, Voronoi diagram, Delaunay simplex, molecular volume, occupied volume, empty volume.

1 Introduction

Ensembles of overlapping spheres are used as models for many real systems. In chemistry and biology the atoms are represented as van der Waals spheres, which are overlapping because of relatively short chemical bonds between them. In materials

sciences packings of conglomerate particles are occurring in sandstones and colloids. The problem of calculating the volume of a molecule was stated many years ago [3,4]. The local packing fraction is studied in the investigation of metal glasses [5]. A complementary task is to find the volume of intermolecular voids, which is important both for understanding protein structures and membrane permeability [6-8]. The volume of interatomic cavities is of interest in the theory of liquids [1] and for porous materials [9,10]. In recent years, there is a growing interest in the calculation of the volumetric characteristics of solutions. The density of water in the hydration shell, the density of the solute molecule, and the occurrence of additional voids in the boundary layer affect the partial molar volume (apparent volume) of a solute molecule in solution. The calculation of these components helps to interpret the data of volumetric measurements [11-15].

Many different methods are known to calculate the occupied and empty volumes in a system of spherical particles. Some of them use analytically derived formulas for the calculation of multiply intersecting spheres explicitly, or use numerical algorithms like Monte Carlo methods, see the papers cited in Refs. [2] and [16].

A novel approach was proposed in Ref. [1] and was applied to the calculation of the volume of interatomic cavities in a monatomic liquid. It substantially uses the Voronoi-Delaunay tessellation of the system. In this case a void between the atoms is composed of the empty volume of Delaunay simplexes. It was proposed to divide a simplex into smaller elements – orthogonal triangular pyramids (subsimplexes). The subsimplex has very important property: its occupied volume is defined by the only atom at the apex of the subsimplex. Thus, for any system of overlapping atoms, explicit formulas for the occupied volume of the subsimplex can be written. Then it was remained to sum (using a “rule of signs”) the empty volumes of the subsimplexes which constitute the Delaunay simplexes of the cavity. (Note that the empty volume is obviously the difference between the total and the occupied volume). The authors of Ref. [1] used classical Voronoi-Delaunay tessellation, because atoms in their system have the same radius. However, they also emphasized that this approach can be implemented for spheres of various radii. In particular, the power (radical) decomposition can be used; but instead of the classical Delaunay simplexes, in this case the dual simplexes of the power Voronoi tessellation should be used.

In Ref. [2] the method of subsimplexes was implemented for the calculation of the volume of a union of overlapping spheres. This problem can be reduced to the determination of the occupied volume of the power Voronoi polyhedra in a system of overlapping spheres of different radii. Summing up the occupied volume of all subsimplexes, associated with a given atom, we find the desired occupied volume of the Voronoi polyhedron of this atom. (Here and below we use the terms Voronoi polyhedron (VP) and Delaunay simplex (DS) for both classical and power tessellations). In Ref. [2] we compared the method of subsimplexes with the other analytical method, which are known for the calculation of volume of a union of overlapping spheres. It was shown it is robust and even a bit faster than “a certified algorithm” [16].

In this paper, we propose to use subsimplexes for the calculation of occupied and empty volumes of various constructions of VP and DS. These may be the Voronoi region of a solute molecule in solution [17], or the Voronoi or Delaunay shells, given by the decomposition of a solution with respect to the solute molecule [15, 18]. Moreover, subsimplexes can help to estimate the intersection of Voronoi and Delau-

ny shells [19]. It helps to calculate the components of the partial molar volume of a macromolecule in solution, what is important for the interpretation of experimental volumetric data for protein solutions. We do not know other analytical approaches for such kind of constructions. Numerical methods (like Monte Carlo) are very slow for the studied problems. Our method is illustrated by the application to molecular dynamics models of a hIAPP polypeptide molecule in water at different temperatures.

2 Voronoi-Delaunay subsimplex

2.1 Two dimensions

Consider an atom A with its Voronoi polygon (VP) and the Delaunay simplex (DS) which corresponds to a vertex V of this polygon, Fig. 1. Join the points A and V by a line segment and draw perpendiculars from the point A to those polygon edges, which meet at the vertex V . For 2D there are only two such polygon edges. Let us denote the base points of the perpendiculars at these edges as E_1 and E_2 . (Note, these perpendiculars coincide with DS edges.) The triangles AVE_1 and AVE_2 are the *Voronoi-Delaunay subsimplexes* (or simple *subsimplaxes*) which correspond to the pair $A - V$. We will call them the duo of subsimplaxes related to the pair $A - V$.

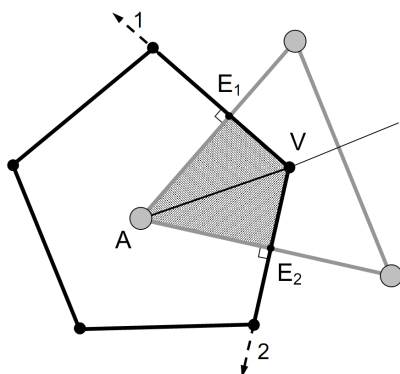

Fig. 1. 2D Voronoi-Delaunay subsimplexes for the Voronoi polyhedron of an atom A and the Delaunay simplex of its vertex V . Points E_1 and E_2 are the bases of the perpendiculars from the point A to the edges which meet at vertex V .

The example shown in Fig. 1 is typical for a more or less homogeneous system. In this case, the duo of subsimplaxes represents the intersection of a VP and a DS. But such an ordinary configuration does not exhaust all situations in physical models. Fig. 2 shows an example, where one of the points E lies outside the VP. In this case the subsimplex AVE_2 of the pair $A-V$ lies outside the Delaunay simplex of the vertex V (Fig. 2a). A piece of this subsimplex is also outside of the Voronoi polyhedron of the atom A .

Such a duo does not represent the intersection of the VP and the DS. However, if we consider two adjacent Delaunay simplexes together (of vertices V and V' , Fig. 2b) we can find the correct volume of intersection of both simplexes and the polygon. In this case (Fig. 2c), by changing the sign of the exterior (inverted) subsimplex AVE_2 , it can be compensated by the subsimplex $AV'E_1'$ (note, the points E_2 and E_1' are identical).

In Ref. [1] it was proposed to mark the volume of subsimplices with different signs. In this example a sign factor S_E is defined, which is determined by the position of point E and the corresponding polygon edge relative to the vertex V. Point E_2 in Fig.2a is on the negative side of an axis (arrow 2), emanating from point V along the edge VV' . In other words, it lies on the other side of the point V than the edge of the polygon). In this case, for the subsimplex AVE_2 the factor is negative, $S_E = -1$. Else, if the point E lies on the edge (as in Fig. 1) or on its continuation, but on the positive side of the axis, emanating from the vertex, as in the case of point E'_1 and vertex V' in Fig. 2b) the factor is positive, $S_E = +1$.

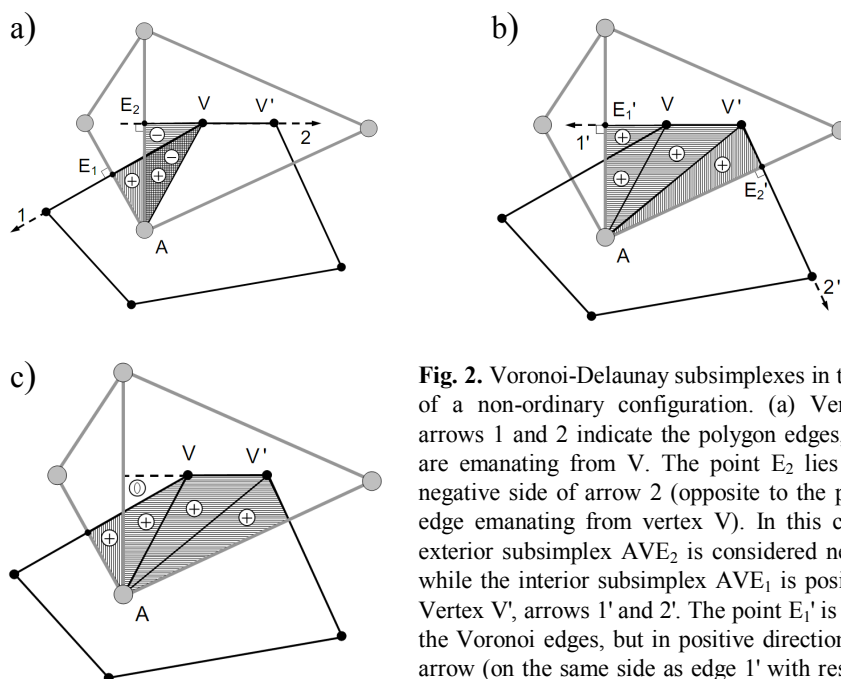

Fig. 2. Voronoi-Delaunay subsimplices in the case of a non-ordinary configuration. (a) Vertex V, arrows 1 and 2 indicate the polygon edges, which are emanating from V. The point E_2 lies on the negative side of arrow 2 (opposite to the polygon edge emanating from vertex V). In this case the exterior subsimplex AVE_2 is considered negative, while the interior subsimplex AVE_1 is positive. (b) Vertex V' , arrows 1' and 2'. The point E'_1 is outside the Voronoi edges, but in positive direction of the arrow (on the same side as edge 1' with respect to vertex V'). In this case, the subsimplex $AV'E'_1$ is considered positive. (c) The sum of the (signed) subsimplices at the vertices V and V' gives the intersection of these Delaunay simplices and the Voronoi polygon.

The symbols "plus" and "minus" in Fig. 2a,b show the signs related with the considered subsimplices. After summing, we will have an area corresponding to the intersection of the simplices V and V' with the polygon A (Fig. 2c).

Recall that when dealing with power Voronoi decomposition, there may be cases when the center of atom A is outside its VP. This occurs when the position of atom A lies deep within the sphere characterizing another atom [20,21], see Fig. 2 in Ref. [2]. In this case point A lies on the other side of a VP face with respect to the VP itself. For all subsimplices, which are based on this face, an additional factor $S_A = -1$ is defined. In all other cases, $S_A = +1$, see Fig. 6 in Ref. [2]. The final sign of the subsimplex in 2D is determined by the product of factors S_E and S_A .

2.2 Three dimensions

Consider the VP of an atom A and the DS of its vertex V, Fig. 3. Three edges of the VP are incident to the vertex (let us denote them as 1, 2, 3), and there are three faces of the VP, which intersect at these edges (let us call them as (1,2), (1,3) and (2,3)). Connect the points A and V by a line segment, and draw perpendiculars from point A to these VP planes (as in 2D, the perpendiculars coincide with DS-edges). The points of intersection of the perpendiculars with the planes are denoted B_{12} , B_{13} , B_{23} .

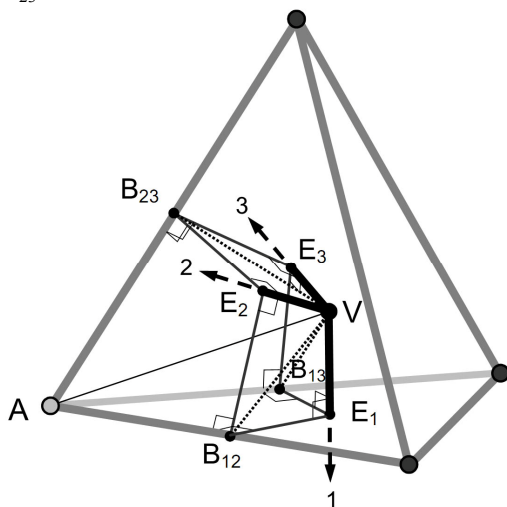

Fig. 3. Three-dimensional Voronoi-Delaunay subsimplices. Point V is a vertex of the VP of atom A. Points B_{12} , B_{13} and B_{23} are the bases of the perpendiculars from A to the Voronoi faces, which meet in V. Points E_1 , E_2 and E_3 are the bases of the perpendiculars from the points B_{12} , B_{13} , B_{23} to the VP edges 1, 2 and 3. The triangles (BVE) are the bases of subsimplices with the vertex A. Six subsimplices (sextet) are associated with each pair A - V.

In each of these planes we have a situation which is similar to the one discussed for 2D, where the point B (which is B_{12} , B_{13} or B_{23}) now plays the role of point A in Figs. 1, 2. Draw perpendiculars from the points B to the edges of their planes, Fig.3. These edges are the VP edges 1, 2, 3. The points of intersection of the perpendiculars with the polyhedron edges (or their continuations) are denoted also as E_1 , E_2 , E_3 . Thus, on each face of the VP we got two right triangles. For example on the plane (1,2) these are $B_{12}VE_1$ and $B_{12}VE_2$. We will consider these triangles as the bases of pyramids with the vertex A as top. These pyramids form the Voronoi- Delaunay subsimplices in 3D.

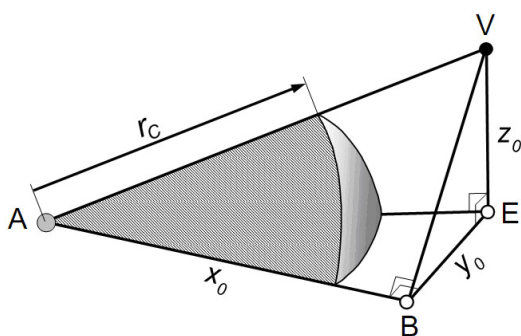

Fig. 4. 3D Voronoi-Delaunay subsimplex of the Voronoi polyhedron of an atom A and the Delaunay simplex of a vertex V of this polyhedron. Point B is the base of the perpendicular from vertex A to the face of the polyhedron. Point E is the base of the perpendicular from the point B to the VP edge, starting from vertex V. The region covered by atom A defines the occupied volume of the subsimplex.

The subsimplexes have a simple shape (Fig. 4), which made it possible to write an explicit expression for the calculation of the occupied volume inside subsimplexes. As discussed in Refs. [1, 2], this volume is completely determined by the atom centered on the vertex A. Some other atom can also overlap with the subsimplex (partially or fully), but this overlapping volume is always covered by atom A. This follows from the fact that the subsimplex is part of the Voronoi polyhedron of atom A. This means that any volume of the subsimplex, which is uncovered by atom A, can not be covered by any other atom of the system.

The formulas for the calculation of the occupied volume and the area of the spherical surface section were first given in Ref. [1]. They are mathematically identical to formulas proposed in Ref. [2], which are represented there in a shorter way. Note, as it was found in our calculations, formula (A8) for the area of the spherical surface section in the pyramid, presented in Ref.[1], is not robust. It is unstable if the subsimplex edge VE tends to zero and at the singular point, where the value of the sphere radius r_C tends to the length of the edge AE. A robust version of this formula is given in Ref. [2].

Here we present the formulas for the occupied volume of the subsimplex, keeping all notations used in Refs.[1,2]. Remember, the subsimplex has one right dihedral angle (between faces ABE and BEV), and therefore right angles between segments AB and BE, and AB and BV, additionally there are right angles between BE and EV, and between AE and EV.

The lengths of the orthogonal edges of the pyramid are x_0, y_0, z_0 , Fig. 4. Thus the length AE is equal to $r_E = \sqrt{x_0^2 + y_0^2}$ and the length AV is $r_V = \sqrt{x_0^2 + y_0^2 + z_0^2}$. The occupied volume depends on which edges of the pyramid are intersected by the surface of the sphere with radius r_C . Thus the following cases are possible:

I: $r_C \leq x_0$

$$V_C = \frac{r_C^3}{6} \left(2\theta - \frac{\pi}{2} - a_1 \right) \quad (\text{A3})$$

II: $x_0 < r_C \leq r_E$

$$V_C = \frac{\theta}{2} \left(r_C^2 x_0 - \frac{x_0^3}{3} \right) - \frac{r_C^3}{6} \left(\frac{\pi}{2} + a_1 \right) \quad (\text{A5})$$

III: $r_E < r_C \leq r_V$

$$V_C = \left(\frac{r_C^2 x_0}{2} - \frac{x_0^3}{6} \right) \left(\theta - \frac{\pi}{2} + a_2 \right) + \frac{r_C^3}{6} (a_3 - a_1) + \frac{x_0 y_0}{6} \sqrt{r_C^2 - r_E^2} \quad (\text{A7})$$

IV: $r_C \geq r_V$

$$V_C = \frac{x_0 y_0 z_0}{6} \quad (\text{A9})$$

where the following notations are used: $\theta = \arctan(z_0/y_0)$, $x_2 = r_C x_0 / r_E$, $y_2 = r_C y_0 / r_E$,

$$a_1 = \arcsin \left[\frac{(z_0^2 x_0^2 - y_0^2 r_r^2)}{r_E^2 (y_0^2 + z_0^2)} \right], \quad a_2 = \arcsin \left[\frac{y_0}{\sqrt{r_C^2 - x_0^2}} \right],$$

$$a_3 = \arcsin \left(\frac{x_2^2 - y_2^2 - x_0^2}{r_C^2 - x_0^2} \right).$$

Two subsimplexes are based on each VP face at vertex V. Each vertex V is common to three faces, so it unites six subsimplexes. Typically, point B lies on a face of the VP, and point E is located on a VP edge. For such ordinary configurations the subsimplexes represent the intersection of the VP of A and the DS of its vertex V, Fig.3. In this case these six subsimplexes are combined into a hexahedron with eight corners, which is isomorphic to a cube, and the line segment AV is its spatial diagonal. However, in general they do not form a convex polyhedron, because the inverted subsimplexes, discussed in the 2D section, exist also in 3D. Nevertheless, it is convenient to combine the subsimplexes into a group (sextet) which is affiliated with the pair A - V.

The rule of sign for the summation of three-dimensional subsimplexes was discussed in Refs. [1, 2]. The sign of a subsimplex is determined by the product of three factors: $S_A \cdot S_E \cdot S_B$. Here a factor S_B is appended to the mentioned factors S_A and S_E for 2D. It reflects the relative positions of point B and the face of the VP, Fig.5.

If point B and the VP face lie on the same side of the edge with the base point E, then the factor S_B for the subsimplex with the base BVE is positive. (For example, in Fig.5a and Fig.5c the factor S_B for the subsimplex with the base BVE1 is positive.). Otherwise, S_B is negative, Fig.5b and Fig.5d. Similarly, for the subsimplex with the base BVE2, the sign is positive in Fig. 5a and Fig.5 b and negative in Fig. 5c and Fig.5 d.

Thus the determination of the subsimplex sign is straightforward: we need to establish the relative position of points on a line (to find the factor S_E), points in a plane relatively to a line (for S_B), and points in space relatively to a plane (for S_A), which can be easily done by elementary analytic geometry.

Note that inverted subsimplexes occur, when the Voronoi vertex V (i.e. the "center" of the DS) is outside its Delaunay simplex. Such a DS is called *open Delaunay simplex* and the corresponding face *open face*. A Delaunay simplex can contain one or two open faces. They usually occur at relatively wide cavities inside atomic systems. If the center is inside, then the Delaunay simplex is called *closed*, and a simplex face which does not separate the body of the simplex and its center is also *closed*. An open face is always adjacent to a closed face of the adjacent simplex [22]. Thus the neighboring simplexes compensate the inverted subsimplexes, see Fig.2. We will call them the *compensating* Delaunay simplexes.

It is interesting to note that all vertices of the sextet lie on the same circumsphere regardless of whether it forms a convex polyhedron or not. This is evident from the fact that the angles at all vertices B and E are right angles and based on the common diagonal AV (Thales' theorem).

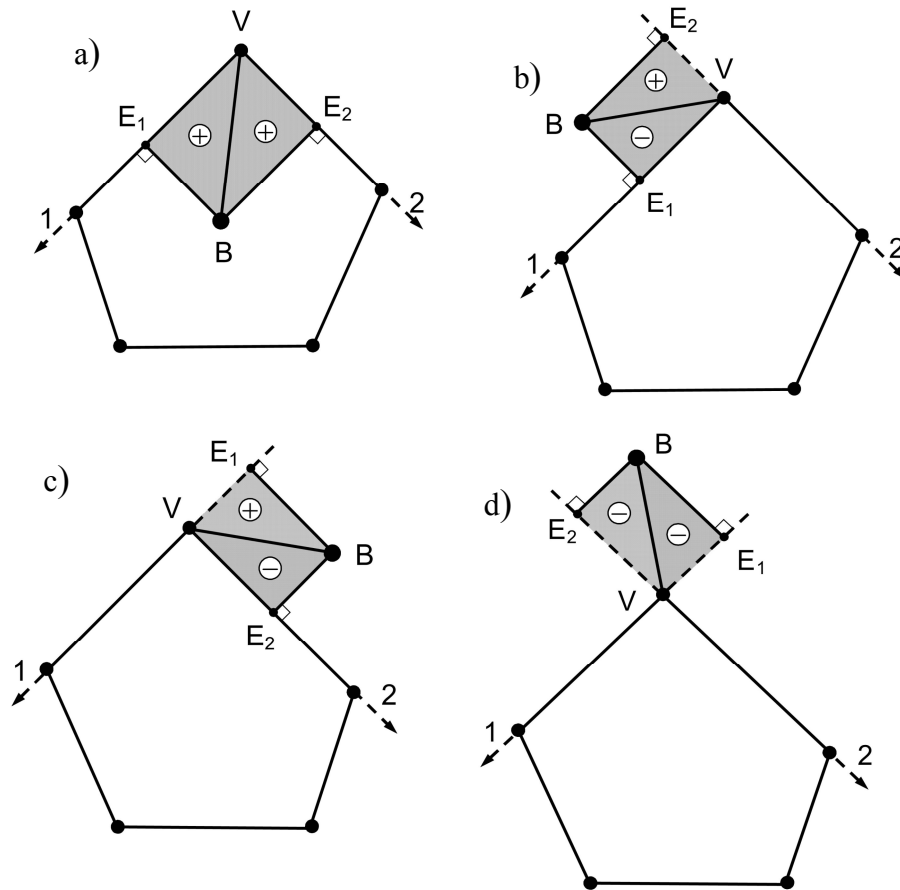

Fig.5. Choosing the sing of the factor S_B for the calculation of the 3D Voronoi-Delaunay sub-simplices. Possible positions of point B relatively a polyhedron face are shown. Symbols (+) and (-) show the sign of S_B for the sub-simplices with the bases BVE1 and BVE2.

Recall that the perpendiculars from point A to the faces of the VP (segments AB_{ik}) coincide with the edges of the DS. Thus our sub-simplices correspond completely to the sub-simplices defined in Ref. [1]. These authors started from a Delaunay simplex and calculated the sub-simplices related to each corner of the Delaunay simplex. This was reasonable for the analysis of interatomic voids, which are represented as clusters of Delaunay simplices. In this paper we discuss pairs A-V without an *a priori* reference to Delaunay simplices, and use the sub-simplices as a general construction element for various structures.

3 Data structure for the recording of subsimplex volumes.

A Voronoi-Delaunay tessellation defines an enumeration of the Voronoi polyhedra (atoms) and Delaunay simplexes. To record their connectivity, a table incidence for the DS and VP is used, where the four numbers of the atoms, which form the i -th DS, are recorded in the i -th row of the table (array):

$$\begin{array}{c|cccc}
 \dots & \dots & \dots & \dots & \dots \\
 i & A_1^i & A_2^i & A_3^i & A_4^i \\
 i+1 & A_1^{i+1} & A_2^{i+1} & A_3^{i+1} & A_4^{i+1} \\
 \dots & \dots & \dots & \dots & \dots
 \end{array} \quad (1)$$

Actually each elements of the array (1) represents a pair A-V, mentioned above: a Voronoi polyhedron of atom A_k^i ($k=1,2,3,4$) and its vertex V, which is the "center" of the Delaunay simplex with the number i . Thus, such data structure can be used also to represent sextets of subsimplexes.

Having the Voronoi-Delaunay tessellation of a system, all subsimplexes are determined and their volumes (total, occupied and empty) are calculated according to the formulas (A3) – (A9). The signs of the subsimplexes are established, and the volumes of the sextets are calculated according to the rule of sign for each pair of VP and DS. These data are written in a table similar to (1):

$$\begin{array}{c|cccc}
 \dots & \dots & \dots & \dots & \dots \\
 i & V_1^i & V_2^i & V_3^i & V_4^i \\
 i+1 & V_1^{i+1} & V_2^{i+1} & V_3^{i+1} & V_4^{i+1} \\
 \dots & \dots & \dots & \dots & \dots
 \end{array} \quad (2)$$

where the elements V_k^i can be the values of the total, the occupied, or the empty volume of the k -th sextet of the i -th DS, ($k=1,2,3,4$).

4 Applications.

The data structure (2) allows the calculation of the volumes of different structural elements, selected in atomic systems by the Voronoi-Delaunay tessellation. Here we discuss some of them.

4.1 Delaunay simplex.

The total, occupied, or empty volume of the i -th simplex is determined by a simple summation of the corresponding elements of the i -th row of the array (2). For the *total* volume, such a summation will always give the correct result, even when the simplex is open. Fig. 6 shows a configuration taken from Fig. 2. Here we sum subsimplexes at the atoms A, A' and A". The signs in the figure had been obtained in accordance with the rules of signs for subsimplexes and mark different parts to the total volume of the simplex of vertex V. We see that a non-zero contribution is obtained only for those parts that compose the considered simplex. In this case, the inverted subsimplexes at the atoms A and A" are compensated by the subsimplexes at the atom A'.

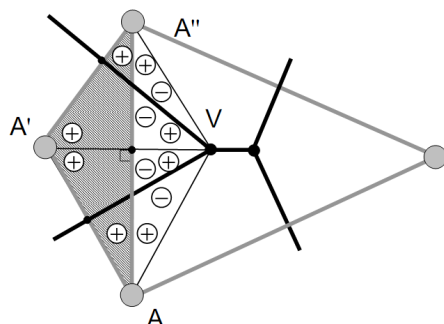

Fig. 6. The summation of the sub-simplex volumes over all atoms of any simplex always gives the correct total volume of the simplex, e.g. simplex A, A', A'' of vertex V).

However, a situation as described in Ref. [1] may appear in the calculation of the *occupied* volume. It is known that a Delaunay simplex may include sections of an *extraneous* atom (not from an own vertex of the simplex), Fig. 7a. The volume of the extraneous atom (A) is not considered in the subsimplices of the neighbor simplex (A', A'', A'''), and therefore can not contribute to the occupied volume of this DS. On the other hand, this volume is taken into account in the subsimplices of the simplex (A, A'' and A'''), which contains atom A as one of its vertexes, although a part of volume A is outside the simplex. Thus, the method of subsimplices does not always give the correct occupied volume inside a given simplex. However, for a cluster of these simplexes, such as the entire cavity between the atoms A, A', A'' and A''' we get the correct value of the occupied volume.

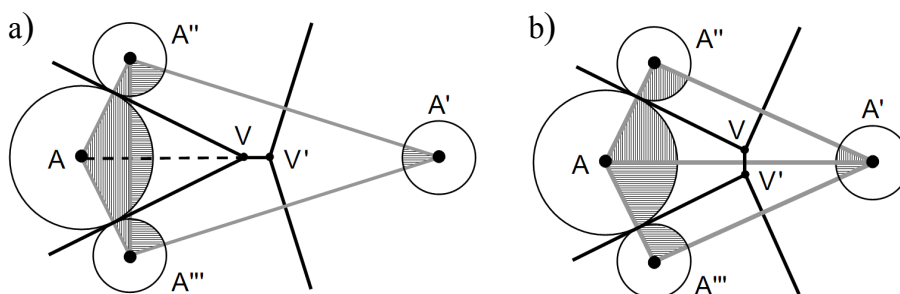

Fig. 7. (a) The penetration of an extraneous atom (A) into the simplex A'A''A'''. (b) By a slight shift of the atom A', the Voronoi-Delaunay tessellation will be modified and this peculiarity disappears.

Note that for molecular systems, studied in physics and biology, the appearance of extraneous atoms in the Delaunay simplexes is a rare event. Fig. 7b shows that the non-ordinary atomic configuration of Fig. 7a becomes ordinary after a small shift of atom A' in a direction which reduces the cavity between the atoms (such a shift may happen with high probability in the subsequent step of a molecular dynamics simulation run of a dense molecular system). A modification of the Voronoi-Delaunay tessellation occurs, and the atom A is no longer an extraneous one for the new DS.

4.2 A local cavity

A *local cavity* is a cluster of Delaunay simplexes, covering a local void in an atomic system. The outer faces of these Delaunay simplexes are closed and coincide with the closed faces of the neighboring simplexes. In other words, non-ordinary configurations are possible only within the cavity, and each simplex of the cluster has its compensating neighbor. As it was emphasized in Ref. [1], the summation of these subsimplexes gives the correct result as for the total, as well as the occupied and the empty volume of the cavity.

Thus, when calculating the volume of a local cavity, it is enough to sum all rows of arrays (2), which belong to the Delaunay simplexes of a given cavity.

4.3 Voronoi polyhedron

Unlike for Delaunay simplexes, an extraneous atom cannot affect the occupied (or the empty) volume within a *Voronoi polyhedron*. Therefore, the subsimplexes related to a VP, always give a correct value for the total, as well as the occupied and the empty volume of the VP, see Ref. [2].

The required sextets can be found with the help of array (1). The number of a given atom A, whose VP is considered, is recorded in those rows of array (1), which characterize those simplexes, which have atom A as one of its vertexes. Then the volumes of the required sextets are located in the same places in arrays (2), where the atom A is located in array (1).

4.4 Voronoi region of a molecule.

The concept of the *Voronoi region of a molecule* in a solution has long been used in molecular biology [3,17]. It is represented by the sum of the Voronoi regions of all atoms of the molecule in solution. Therefore, the calculation of the volume (total, occupied or empty) by the subsimplexes is straightforward, see 4.3.

Note some subtle differences between the concepts of the *occupied (or empty) volume of the Voronoi region of a molecule* and the *molecular volume*, which are used in molecular biology, and can be calculated using the subsimplexes. One usually supposes that the occupied volume of the Voronoi region of a molecule is the van der Waals volume of the molecule. This is true only for the case, when atoms of the molecule do not cross the outer faces of the Voronoi region of molecule. An overlap between an atom of the molecule and an atom of the solvent is shown in Fig. 8. As a result, a part of the atom of the molecule is outside its Voronoi region. Usually only a small fraction of the volume is lost, and the numeric difference between the occupied and the van der Waals volumes is negligible for molecular systems (such overlaps are rare events in molecular systems, due to the strong repulsion between close atoms). We should keep in mind, the van der Waals volume of the molecule is defined as the union of its atoms independently on the solvent.

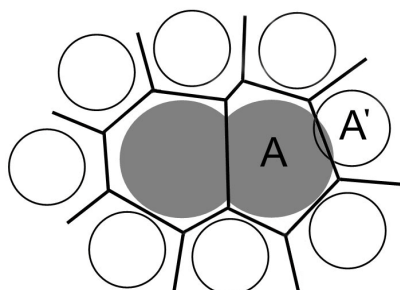

Fig. 8. Occupied volume of the Voronoi region of a solute molecule. A part of an atom A of the molecule lies outside the Voronoi surface of the molecule due to the overlap of this atom with an atom A' of the solvent. This part does not contribute to the occupied Voronoi volume of the solute molecule.

The *molecular volume* is the van der Waals volume of the molecule together with the volume of the inner voids. This is a rather qualitative concept, but a way for a quantitative recording of this value can be adopted. Usually it is calculated with the help of a Connolly surface [4]. The Voronoi-Delaunay technique provides an alternative approach. The molecular volume can be calculated by subtracting the volume of the boundary voids from the total volume of the Voronoi region of the molecule. In section 4.7, we discuss how to estimate the volume of these voids. The molecular volume can be also calculated directly by summing the *occupied* volume of the Voronoi region and the *empty* volume of the Delaunay simplexes, which represent the inner voids of the dissolved molecule (i.e. the DS having vertices that lie only on the atoms of the solute molecule).

4.5 Voronoi shell.

The *Voronoi shell* is defined as an envelope of solvent (water) molecules around the solute molecule. This construction was first proposed in Ref. [23] to allocate the hydration shell. It can also be used to define successive shells of the solvent, surrounding the dissolved macromolecule [18].

Each Voronoi shell is represented by a list of Voronoi polyhedra, forming this shell. Since for each VP its total and occupied volumes are calculated accurately (see 4.3), it only remains to sum all VP, forming the shell, in order to get the desired volume of the Voronoi shell.

4.6 Delaunay shell.

Delaunay shells were proposed for the detection of interatomic voids around the solute molecule [15, 18]. The first Delaunay layer is formed by those Delaunay simplexes, which have vertices of both classes of atoms: from the solute molecule and the solvent. It is a solid shell of Delaunay simplexes around the molecule [18].

The method of subsimplexes gives the correct result for the total volume of the Delaunay layer, since it is the sum of the total volumes of the individual Delaunay simplexes, which are calculated correctly (see section 4.1).

The occupied and the empty volume may have some inaccuracy. This is due to the fact that some DS of the Delaunay shell can have open faces on the outer or inner surface of the Delaunay shell. This means that an extraneous atom can penetrate into the layer, and its volume will be taken into account incorrectly (see section 4.1). However, from our experience, this discrepancy is small enough for molecular sys-

tems. We performed calculations with the molecular models discussed in section 5, to compare the results, obtained by the method of subsimplexes and by a different one, which we had used in our previous works (see e.g. Ref. [7]). This method combines analytical and numerical calculations to find the empty volume of a DS. First, the surroundings of a given DS is examined. If there are no extraneous atoms and at most a triple overlap of spheres, then analytical calculations of the empty volume are performed. Else, the empty volume of such a simplex is calculated numerically. We used this method as reference. It turned out that the maximum difference between the methods does not exceed 1% after the treatment of 1000 independent configurations of the bio-molecule hIAPP in water. A temperature increase can increase the difference, because the overlapping of atoms is magnified. However it is only marginal, about 0.1% in the whole studied temperature interval. This discrepancy can be ignored in our studies of bio-molecules. Note that the calculations by the method of subsimplexes turned out to be two times faster than by our smart combined method.

To compute the occupied or the empty volume of a Delaunay shell, it is sufficient to sum those rows of array (2), which contain the simplexes of a given Delaunay shell.

4.7 Intersection of Voronoi and Delaunay shells.

Of special interest is the empty volume of the intersection of Voronoi and Delaunay shells [19]. The method of subsimplexes allows its calculation, but with some inaccuracy, because the intersection may consist of incomplete parts of Voronoi polyhedra and Delaunay simplexes. In this case, some of the inverted subsimplexes can be uncompensated. Fig. 9 illustrates such a configurations, where two parts of the Voronoi shell fall outside the Delaunay shell. The volumes, which are sticking out will be incorrectly included in the total volume of the intersection.

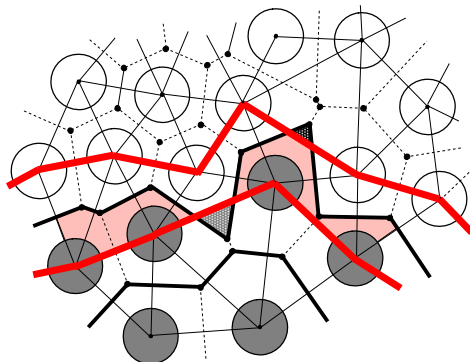

Fig. 9. Illustration of a Voronoi shell, which extends beyond the Delaunay shell. The two areas, , which are sticking out, are dashed. Bold (red) lines border the Delaunay shell. Semi-bold (black) lines show the Voronoi shell. The intersection between the Voronoi and Delaunay shells is shaded (pink). Dark disks are atoms of the solute molecule, light disks are atoms of the solvent.

In addition, there is the problem of extraneous atoms (see 4.1). However, we also think that the resulting inaccuracy is insignificant for our purposes. Unfortunately we can not make a quantitative estimation of the inaccuracy. We do not know any other method to calculate the empty volume of the intersection, which could be applicable for large solute molecules.

Thus, to calculate the empty volume of the intersection, we need to choose those rows in array (2), which correspond to the Delaunay simplexes of the given Delaunay

shell, but to sum only those sextets which are related to the atoms (VPs) of the given Voronoi shell.

5 Application to the calculation of the volumetric characteristics of solutions

The apparent volume of a solute molecule V_{app} (which is the partial molar volume at infinite dilution) consists of the molecular volume (V_M) of the solute molecule, the additional void volume at the boundary between solute molecule and solvent, and the contribution of the solvent due to a local change of the solvent density under the influence of the solute (ΔV). The value V_{app} is measured in physical experiments or calculated independently in computer simulations. The Voronoi-Delaunay method helps to find the components [19].

Fig. 10 illustrates a fragment of a solute molecule in solution. The inner and outer boundaries of the first Delaunay shell (dashed lines) and the outer surface of the Voronoi region of the molecule (solid line) are shown. The Voronoi region of the molecule consists of the molecular volume V_M and a part of the empty volume around the molecule (in Ref. [19] it is marked V_B^M : the part of the boundary volume, which is assigned to the molecule). Thus $V_{Vor} = V_M + V_B^M$. These volumes can be calculated as it is described above in sections 4.4 and 4.7.

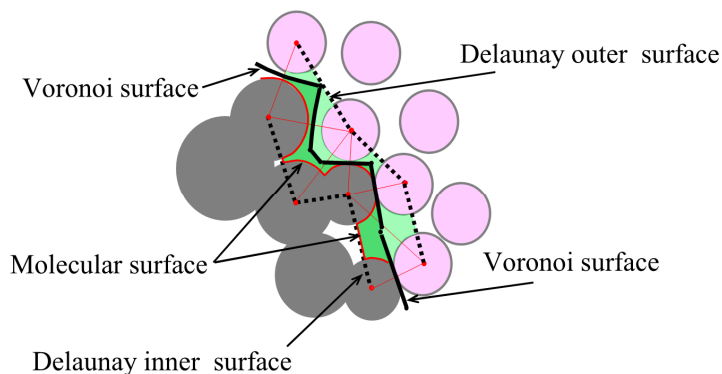

Fig. 10. A fragment of the boundary area between a solute molecule (dark disks) and the solvent (light disks), taken from [19]. The black thick solid line shows the border of the *Voronoi region of the molecule* (V_{Vor}), the so called *Voronoi surface*. Dotted lines show the inner and outer surfaces of the first *Delaunay shell*. The dark-green area is the boundary empty volume assigned to the solute molecule (V_B^M). The red thick line over the atomic surfaces and the faces of the Delaunay simplexes represents the surface of the *molecular volume* (V^M) of the solute molecule.

We used the molecular-dynamic models of a single amyloidogenic polypeptide molecule (hIAPP) in aqueous solution, generated in Ref. [14] for different temperatures. 1000 independent configurations, equally spaced over the equilibrated production runs, were used for averaging. Fig. 11 shows the apparent volume and its compo-

nents for the hIAPP molecule as functions of temperature. V_{app} has been determined in Ref. [15] and the contribution of solvent was calculated as $\Delta V = V_{app} - V_{Vor}$.

It is known, that V_{app} always grows with temperature. However, its components behave in different ways. The molecular volume V_M is practically constant with temperature, but the empty volume V_B^M increases. Thus one can see, the apparent volume grows because of the increase of this boundary empty volume and the decrease of the *negative* contribution of the solvent ΔV .

These calculations explain the nature of the thermal expansion coefficient of hIAPP molecule in water. It is related to the surrounding water, but not to conformational or density changes of the molecule itself.

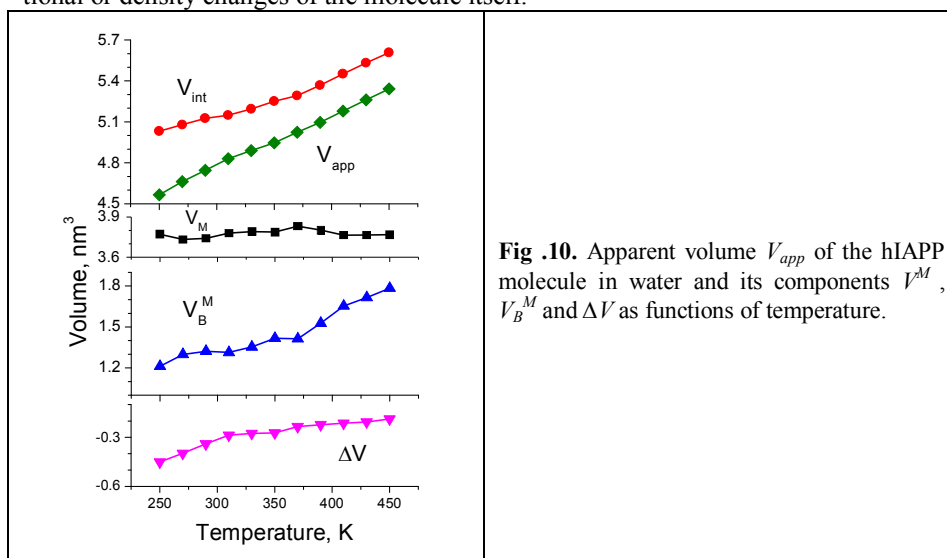

Fig .10. Apparent volume V_{app} of the hIAPP molecule in water and its components V^M , V_B^M and ΔV as functions of temperature.

6 Conclusion

This paper describes the application of Voronoi-Delaunay subsimplexes, discussed in Ref. [1, 2], for the calculation of the occupied and empty volumes in molecular systems. A subsimplex is a triangular pyramid constructed at the intersection of a Voronoi polyhedron and a Delaunay simplex. There are analytical formulas, to calculate the occupied volume inside the subsimplex. These formulas and the use of a convenient data structure to record the subsimplexes, enables a fast calculation of the required volumes. Summing up the subsimplexes (using a rule of signs), the occupied (or the empty) volume can be calculated for various structures, composed of Voronoi polyhedra, Delaunay simplexes and their intersections. In some cases the calculated volume might be flawed by slight inaccuracies because of the peculiarities of the Voronoi-Delaunay tessellation in some rarely occurring local packing structures, but its magnitude is not significant for the application to molecular and atomic systems.

To interpret the experimental volumetric data for protein solutions, one needs to know the components of the partial molar volume of the solute molecule and their

change with temperature or pressure. Traditionally, the considered components are the volume of the solute molecule itself (molecular volume), the density change in the hydraton water under the influence of the solute (ΔV), and the contribution of additional voids at the border between the solute molecule and the solvent (which relates with the so called thermal volume). The decomposition of the solution into Voronoi and Delaunay shells helps to select corresponding areas in computer models of solutions, and the proposed approach of the subsimplexes enables the calculation of the desired volumes. Using as an example a molecular dynamics model of the protein hIAPP in water, the components of the apparent volume of the molecule were calculated as a function of temperature [19]. This explains the nature of the thermal expansion coefficient of the hIAPP molecule. It originates from the surrounding voids, but not from the molecule itself.

Acknowledgments.

Financial support from Alexander von Humboldt foundation and RFFI grant No.12-03-00654 is gratefully acknowledged. We thank M. Andrews and R. Winter for providing us with the trajectories of their hIAPP simulations.

References

1. Sastry, S., Corti, D.S., Debenedetti, P. G., Stillinger, F.H.: Statistical geometry of particle packings. I. Algorithm for exact determination of connectivity, volume, and surface areas of void space in monodisperse and polydisperse sphere packings. *Phys. Rev. E*, vol. 56(5), 5524–5532 (1997).
2. Voloshin, V.P., Anikeenko, A.V., Medvedev, N.N., Geiger, A.: An Algorithm for the Calculation of Volume and Surface of Unions of Spheres. Application for Solvation Shells. Proceedings of the 8th International Symposium on Voronoi Diagrams in Science and Engineering, ISVD-2011, 170-176 (2011).
3. Richards, F.M.: Calculation of molecular volumes and areas for structures of known geometry. *Methods Enzymol*, vol. 115, 440–464 (1985).
4. Connolly, M. L.: Computation of Molecular Volume. *J. Am. Chem. Soc.*, vol. 107, 1118–1124 (1985).
5. Yang, L., Guo, G.Q., Chen, L.Y., Huang, C.L., Ge, T., Chen, D., Liaw, P. K., Saksli, K., Y. Ren, Q.S. Zeng. B. LaQua, F.G. Chen, J. Z. Jiang: Atomic-Scale Mechanisms of the Glass-Forming Ability in Metallic Glasses. *Phys. Rev.Lett.*, vol. 109, 105502 (2012).
6. Liang, J., Edelsbrunner, J, H., Fu, P., Sudhakar, P., Subramaniam, S.: Analytical shape computation of macromolecules: II. Inaccessible cavities in proteins. *Proteins: Struct. Func. Genet.*, vol. 33, 18-29, (1998).
7. Alinchenko, M.G., Anikeenko, A.V., Medvedev, N. N., Voloshin, V. P., Mezei, M., Jedlovszky, P.: Morphology of voids in molecular systems. A Voronoi-Delaunay analysis of a simulated DMPC membrane. *J. Phys. Chem. B*, vol. 108(49), 19056–19067 (2004).
8. Kim, D., Cho, C.-H., Cho, Y., Ryu, J., Bhak, J., Kim, D.-S.: Pocket extraction on proteins via the Voronoi diagram of spheres. *Journal of Molecular Graphics and Modelling*, vol. 26 (7), 1104-1112 (2008).
9. Rémond, S., Gallias, J. L., Mizrahi, A.: Characterization of voids in spherical particle systems by Delaunay empty spheres. *Granular Matter*, vol.10, 329–334 (2008).

10. Kurzidim, J., Coslovich, D., Kahl, G.: Dynamic arrest of colloids in porous environments: disentangling crowding and confinement. *J. Phys.: Condens. Matter*, vol 23, 234122 (2011).
11. Chalikian T.V.: Volumetric Properties of Proteins. *Annu. Rev. Biophys. Biomol. Struct.* vol. 32, 207–35 (2003).
12. Marchi, M.: Compressibility of Cavities and Biological Water from Voronoi Volumes in Hydrated Proteins. *J. Phys. Chem. B*, vol. 107, 6598-6602 (2003).
13. Mitra, L., Smolin, N., Ravindra, R., Royer, C., Winter, R.: Pressure perturbation calorimetric studies of the solvation properties and the thermal unfolding of proteins in solution—experiments and theoretical interpretation. *Phys. Chem. Chem. Phys.*, vol. 8, 1249–1265 (2006).
14. Brovchenko, I., Andrews, M. N., Oleinikova, A.: Volumetric properties of human islet amyloid polypeptide in liquid water. *Phys. Chem. Chem. Phys.*, vol. 12, 4233–4238 (2010).
15. Voloshin, V.P., Medvedev, N.N., Andrews, M.N., Burri, R.R., Winter, R., Geiger, A.: Volumetric Properties of Hydrated Peptides: Voronoi-Delaunay Analysis of Molecular Simulation Runs, *J. Phys. Chem. B*, vol. 115(48), 14217–14228 (2011).
16. Cazals, F., Kanhere, H., Lorient, S.: Computing the volume of a union of balls: a certified algorithm, *ACM Transactions on Mathematical Software*, vol. 38 (1), 3 (2011).
17. Procacci, P., Scateni, R.: A General Algorithm for Computing Voronoi Volumes: Application to the Hydrated Crystal of Myoglobin. *International Journal of Quantum Chemistry*, vol. 42, 1515-1528 (1992).
18. Kim, A.V., Voloshin, V.P.; Medvedev, N.N.; Geiger, A.: Decomposition of a protein solution into Voronoi shells and Delaunay layers: Calculation of the Volumetric Properties. M.L. Gavrilova et al. (Eds.): *Trans. on Comput. Sci. XX, LNCS 8110*, pp. 56–71, 2013.
19. Voloshin, V.P., Kim, A.V., Medvedev, N.N., Winter, R., Geiger, A.: Calculation of the volumetric characteristics of macromolecules in solution by the Voronoi-Delaunay technique. *J Phys. Chem. B.* (2014), submitted.
20. Mezei, M.: Modified proximity criteria for the analysis of the solvation of a polyfunctional solute. *Molecular Simulation*, vol. 1(5), 327–332 (1988).
21. Aurenhammer, F.: Power diagrams: properties, algorithms and applications. *SIAM J Comput.* vol. 16, 78–96 (1987).
22. Medvedev, N.N., Voronoi-Delaunay method for non-crystalline structures. SB Russian Academy of Science, Novosibirsk (2000) (in Russian)
23. David E.E., David, C.W.: Voronoi Polyhedra as a Tool for Studying Solvation Structure. *J. Chem. Phys.*, vol. 76, 4611 (1982).
24. Andrews, M.N., Winter R.: Comparing the Structural Properties of Human and Rat Islet Amyloid Polypeptide by MD Computer Simulations. *Biophys. Chem.* vol. 156, 43-50 (2011).